



MIPI ALLIANCE DEVELOPERS  
CONFERENCE

**Peter Lefkin**  
**MIPI Alliance Executive Director**

**State of the Alliance**

20-21  
SEPTEMBER  
2022

2003

# THE CELLPHONE MARKET



2003

**MIPI ALLIANCE  
FORMED TO  
STANDARDIZE  
CAMERA AND  
DISPLAY  
INTERFACES**



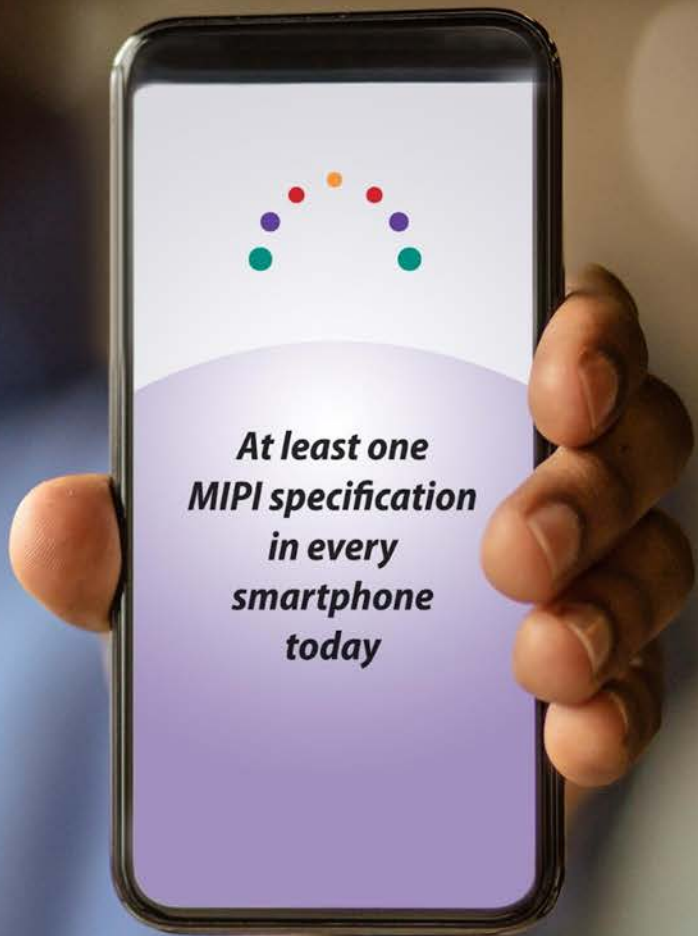

**MIPI ALLIANCE HAS  
DEVELOPED MORE THAN  
50 SPECIFICATIONS  
COVERING THE FULL  
RANGE OF INTERFACE  
APPLICATIONS NEEDED  
FOR MOBILE DEVICES**

# MIPI Specifications Leveraged Beyond Mobile

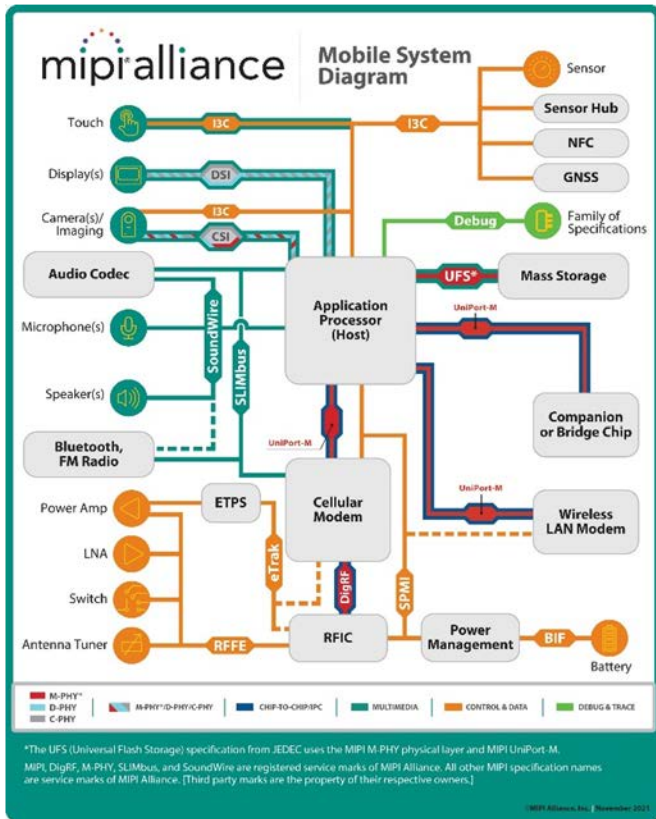

**50+**  
Current specifications

*Fundamentally, usage rights are granted to members royalty free for implementation of MIPI specifications from all MIPI members*

# MIPI Membership Continues to Grow

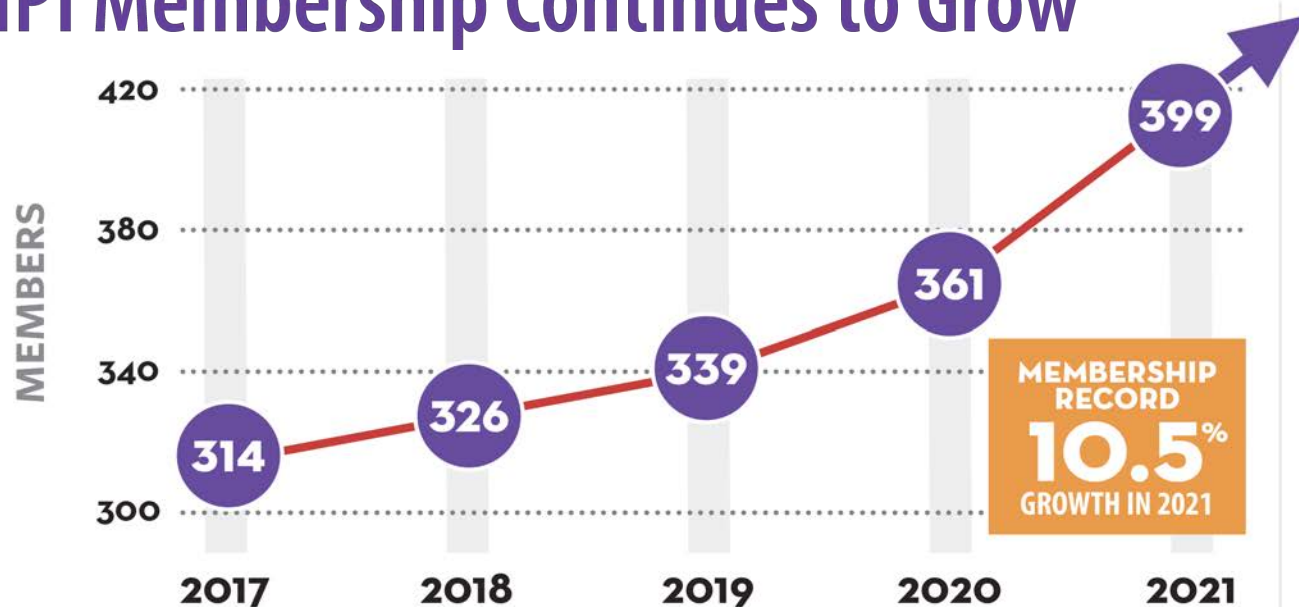

**STRONG PATH  
CONTINUES**

2022 TO DATE

**408**  
MEMBERS

**60**  
NEW MEMBERS

**7**  
NEW CONTRIBUTORS

**FIVE-YEAR MEMBERSHIP GROWTH  
(# OF COMPANIES):  
+27.1%**

# MIPI Alliance Member Ecosystem

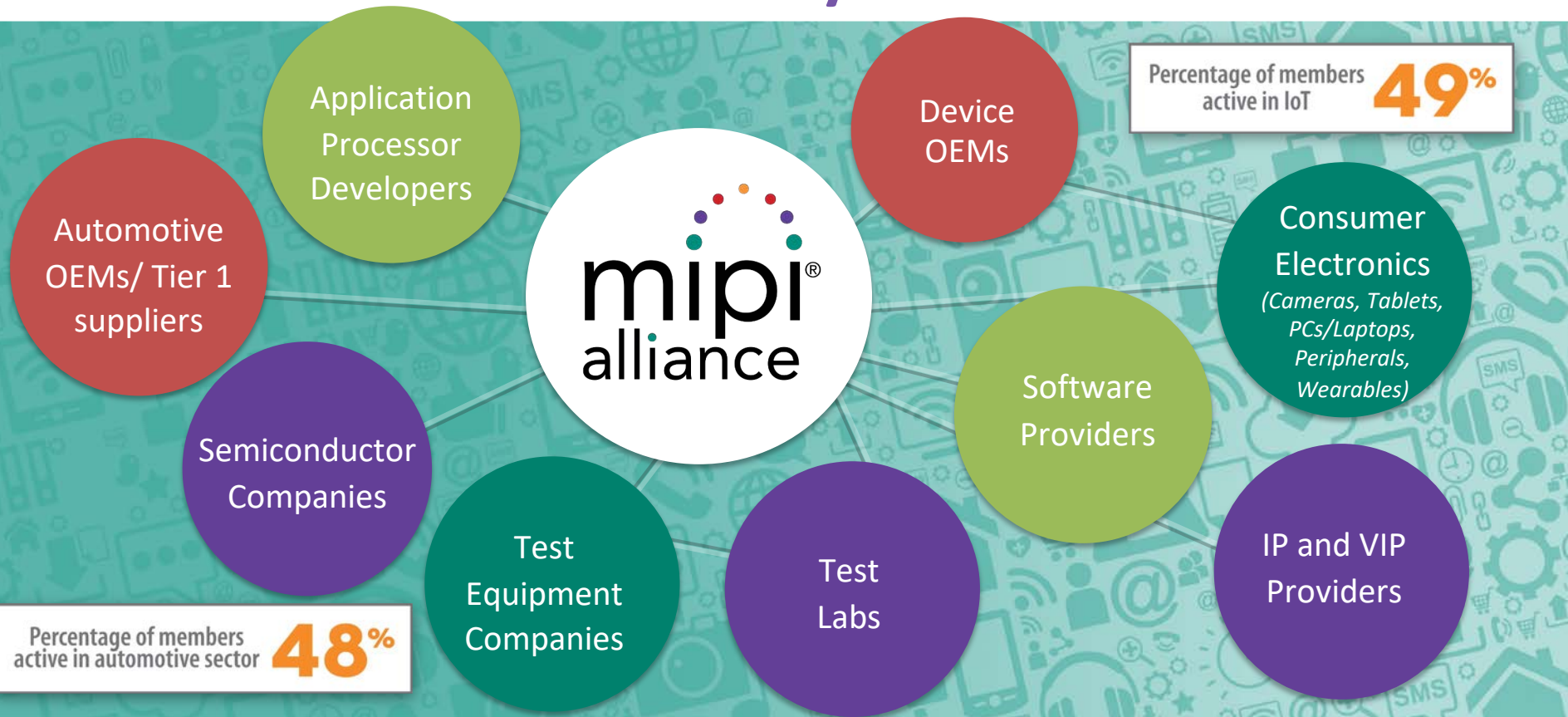

## Board Members



## Contributor Members





# MIPI Groups

**Board of Directors**

## STEERING GROUPS

**Technical Steering Group**

**Marketing Steering Group**

**PHY Steering Group**

## TECHNICAL WORKING GROUPS

**Audio**

**Camera**

**Debug**

**Display**

**I3C**

**A-PHY**

**C-PHY**

**D-PHY**

**M-PHY**

**RFFE**

**Security**

**Software**

**Test**

**UniPro**

## SUBGROUPS & OTHER GROUPS

**Audio PHY Subgroup**

**Camera Adaptation Layer Subgroup**

**Camera Service Extension Subgroup**

**DevCon Steering Committee**

**Display PAL/eDP-DP Subgroup**

**I3C Basic Ad Hoc Working Group**

**I3C HCI Subgroup**

**IoT Interest Group**

**SoundWire Device Class Subgroup**

**TSG Automotive Subgroup**

# Liaisons: Extending The MIPI Ecosystem



# MIPI Alliance Team

## Technical Operations



**Rob Anhofer**  
Director of  
Operations, PM  
for TSG



**Ankit Rohatgi**  
PM for Audio,  
Auto, I3C/Basic  
& Test



**George Goodman**  
PM for A-PHY, Display,  
RFFE & Security



**Rob Santoro**  
PM for Camera,  
M-PHY & Software



**Katie Valenti**  
PM for Debug &  
UniPro



**Chris Grigg**  
Lead Technical Editor  
& Specification  
Document Manager



**Eddie Ashfield**  
Technical Author



**Peter Lefkin**  
Executive Director

## Marketing, Membership & Events



**Sharmion Kerley**  
Director of Marketing  
and Membership



**Dervla O'Reilly**  
Senior Event Manager,  
PM for MIPI DevCon SC



**Lisa Magliaro**  
Senior Membership  
Coordinator



**Christina Slape**  
Member  
Communications



**Melanie Cole**  
Special Projects  
Manager



**Becky Obbema**  
Interprose PR for  
MIPI



**Michele  
Scarletella**  
IoT Technical  
Consultant



**Haran Thanigasalam**  
Camera and Imaging  
Consultant



MIPI ALLIANCE DEVELOPERS  
CONFERENCE

## Recent Milestones

20-21  
SEPTEMBER  
2022

# Return to In-Person Member Meetings



## Leadership transition



## I3C Interop Workshop



## Annual Awards Ceremony



## Demo Day



UPCOMING MEMBER MEETINGS IN  
**VANCOUVER**  
(October 2022)  
& **LISBON**  
(March 2023)

# Strategic Priorities



*Technical  
Roadmap*



*Adoption  
&  
Enablement*



*Security*



*Beyond Mobile*

Includes automotive  
and IoT focus areas

# Technical Roadmap

9

Specifications  
Adopted (YTD)

12

total  
by EOY  
2022

17

Adoptions  
in 2021



Opening Session  
tomorrow

*Inclusive language updates on track*

## LIAISON MILESTONES

MIPI I3C Basic  
in ETSI SSP



USB I3C Device  
Class Specification

**USB**

Enabling Connections™

JEDEC UFS Incorporates  
MIPI UniPro® v2.0  
& MIPI M-PHY®

**JEDEC**

What's New and Coming Up on the  
MIPI PHY Roadmap

21 SEP | 07:05-07:45 PDT

20-21  
SEPTEMBER  
2022



**Kirill Dimitrov**  
MIPI M-PHY Working Group  
Chair



**Edo Cohen**  
MIPI A-PHY Working Group  
Co-Chair



**Raj Kumar Nagpal**  
MIPI A-PHY Working Group  
Co-Chair



**George Wiley**  
MIPI C-PHY Working Group  
Chair

**SPEAKERS**

mipiDEVCON

MOBILE & BEYOND

# Security

mipi<sup>®</sup>  
alliance



Contributor members  
invited to join the  
Security Working Group



Don't miss the  
Security session  
later today

## MIPI CSI-2 Security Framework

20 SEP | 09:45-10:25 PDT

20-21  
SEPTEMBER  
2022



**Philip Hawkes**  
MIPI Security  
Working Group  
Co-Chair



**Rick Wietfeldt**  
MIPI Security  
Working Group  
Co-Chair

**SPEAKERS** mipiDEVCON MOBILE & BEYOND



# Beyond Mobile: Automotive



More automotive sessions today

20-21 SEPTEMBER 2022

**MIPI Automotive SerDes Solutions:  
New Developments in A-PHY and the MASS  
Connectivity Framework**

20 SEP | 07:30-08:10 PDT



**Ariel Lasry**  
Qualcomm

**Edo Cohen**  
Valens Semiconductor

**Raj Kumar Nagpal**  
Synopsys, Inc.

**SPEAKERS** mipiDEVCON MOBILE & BEYOND

20-21 SEPTEMBER 2022



**How to Engage in Data-Driven  
Development and Testing Using  
MIPI Automotive Sensor Interfaces**

20 SEP | 08:15-08:55 PDT

**Gregor Sievers, Ph.D.**  
dSPACE GmbH

mipiDEVCON

**SPEAKER** MOBILE & BEYOND

20-21 SEPTEMBER 2022

**MIPI Sensor Solutions for  
Autonomous Driving**

20 SEP | 09:00-09:40 PDT



**Joe Rodriguez**  
Rambus, Inc.

**Justin Endo**  
Mixel, Inc.

**SPEAKERS** mipiDEVCON MOBILE & BEYOND

# Beyond Mobile: IoT

**mipi**<sup>®</sup>  
alliance

  
NEW MIPI WHITE PAPER  
**Achieving Power Efficiency  
in IoT Devices with MIPI I3C<sup>®</sup>**  
Find out how I3C features  
support energy-efficient designs

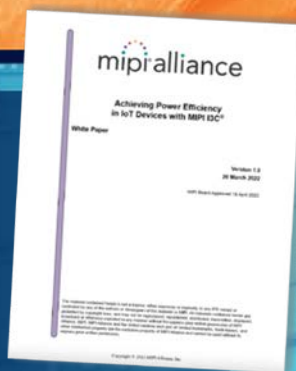

**Join the IoT  
Interest Group**  
(Open to Adopter members)

# Adoption & Enablement

## 2022 Events



**MIPI A-PHY<sup>SM</sup>**  
**Automotive Industry Forum**

Find out what's new in A-PHY v1.1 and help shape the next version of the SerDes interface

26 January 2022 | 08:00-09:30 PST

January Automotive Industry Forum



**WEBINAR**

**Achieving Optimal Energy and Power Efficiency in IoT Devices with MIPI I3C<sup>®</sup>**

3 May 2022 | 08:00 - 09:00 (PDT)

**Tim McKee**  
MIPI I3C Working Group Chair

**Michele Scarletella**  
IoT Technical Consultant to MIPI Alliance

May Webinar: MIPI Webinar: Achieving Optimal Energy and Power Efficiency in IoT Devices with MIPI I3C

Industry Conferences



## New Resources

- Technical Supporting Documents
- Articles on the MIPI Blog
- IoT White Paper: Achieving Power Efficiency in IoT Devices with MIPI I3C



Subscribe to the MIPI Alliance Blog:  
**THE WIRES BEHIND WIRELESS**

**SUBSCRIBE NOW**



**NEW MIPI WHITE PAPER**

**Achieving Power Efficiency in IoT Devices with MIPI I3C<sup>®</sup>**

Find out how I3C features support energy-efficient designs



**MIPI Automotive Workshop**

**15 November 2022**  
07:00-10:30 PST  
Live Virtual Event

**REGISTER NOW**



**COMING IN NOVEMBER:**  
**MIPI Automotive Workshop**

# Looking Forward to 2023

# 15+

## SPECIFICATIONS

*Projected for 2023*

## EXPECTED RELEASES

- SoundWire I3S (SWI3S)
- MIPI Security Specification
- MIPI A-PHY v2.0
- New A-PHY PALs
- Updated Camera & Display Service Extensions

mipi  
**DEVCON**  
**2023**



## MEMBER MEETINGS

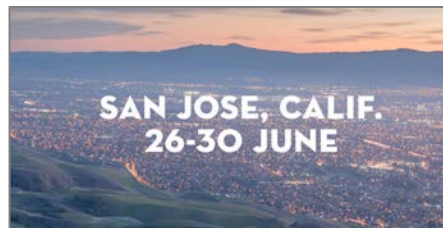
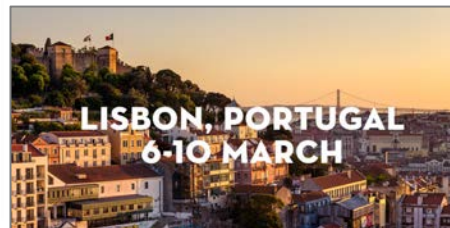



MIPI ALLIANCE DEVELOPERS  
CONFERENCE

THANK  
YOU!

20-21  
SEPTEMBER  
2022